



**KONGSBERG**

# TECHNICAL INFORMATION

## **MS1000 2U STANDARD PROCESSOR**

**P/N 901-10320000**

Specifications subject to change without notice  
901-10327902 Iss. 1.0

**KONGSBERG MESOTECH LTD. 1598 Kebet Way, Port Coquitlam B.C. Canada V3C 5M5**  
**Tel: (604) 464 8144 Fax: (604) 941 5423**



# MS1000 SONAR STANDARD PROCESSOR



KONGSBERG

P/N 901-10320000



The MS1000 Sonar Processor is a 2U Maritime Rackmount solution for operating scanning sonar heads through a high speed digital interface. This unit features Intel® processor technology and is designed and certified to be used in maritime and offshore applications.

The 2U computer is fitted with one Moxa PCIe board that provides a total of four isolated high speed serial ports for providing the fastest telemetry link speed of 921.6 kbps. The processor comes preconfigured with the specific version of MS1000 software being purchased with the processor.

## TECHNICAL SPECIFICATIONS

---

<b>Processor:</b>	Intel i7 QuadCore 3.1 GHz Processor
<b>RAM:</b>	16 GB
<b>Operating system:</b>	Windows 7 64-bit Ultimate
<b>Integrated HD Graphics (3 ports):</b>	Max 2560 x 1600 @ 60 Hz for DVI-I/VGA, DVI-D and DP (Display Port)
<b>Storage:</b>	1 TB Hard Drive
<b>Integrated Interface Ports:</b>	1 x USB 1.1 2 x USB 2.0 2 x USB 3.0 1 x RS-232 2 x RS-422/RS485 2 x 10/100/1000 Mbps Intel® I217/I210 Gigabit LAN 2 x 10/100/1000 Mbps Realtek 8111E Gigabit LAN Isolated COM ports (RS-232/422/485)
<b>Auxiliary Interface Ports (4 ports):</b>	RS485 for Sonar ports (configured for 921600 kbps)
<b>Digital Telemetry:</b>	110/220VAC 50/60Hz @ 150W max
<b>Power Requirement:</b>	-15 to +55°C operating
<b>Temperature Range:</b>	-20 to +60°C storage
<b>Material:</b>	Heavy-duty steel
<b>Dimensions:</b>	Height: 3.46" / 88 mm Width: 16.93" / 430 mm Depth: 18.15" / 461 mm
<b>Weight:</b>	22.0 lb/10 kg
<b>Certification:</b>	IEC 60945, IACS E10, EN61162, EU RO MR

# OUTLINE DRAWINGS

BOTTOM VIEW

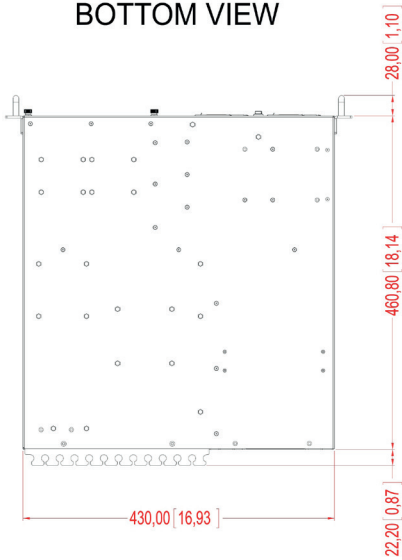

TOP VIEW

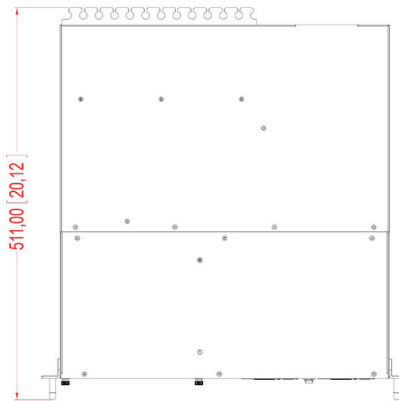

DIMETRIC VIEW

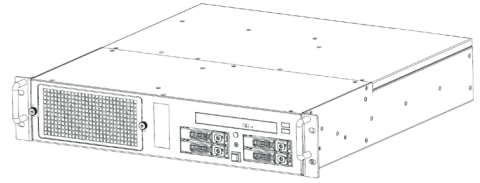

FRONT VIEW

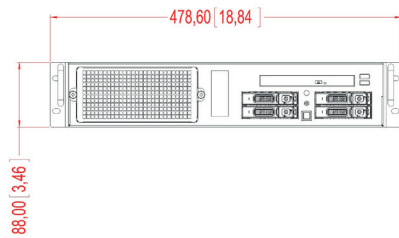

SIDE VIEW

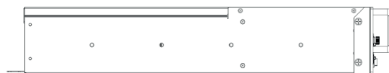

BACK VIEW

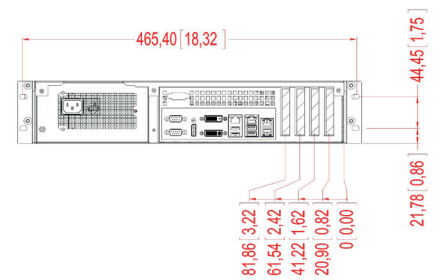

Specifications subject to change without any further notice.  
Images courtesy of Hatteland Display AS.

DIMENSIONS ARE IN MM [INCHES]  
901-10327901-1.2

## Document revisions

Version	Date	Written by	Checked by	Approved by
1.0	Mar 13, 2015	SC	AZ	

## About this document

The information contained in this document is subject to change without prior notice. Kongsberg Mesotech Ltd. shall not be liable for errors contained herein, or for incidental or consequential damages in connection with the furnishing, performance, or use of this document.

© 2015 Kongsberg Mesotech Ltd. All rights reserved. No part of this work covered by the copyright hereon may be reproduced or otherwise copied without prior permission from Kongsberg Mesotech Ltd.

### **Kongsberg Mesotech Ltd.**

1598 Kebet Way  
Port Coquitlam, BC  
V3C 5M5 Canada

Telephone: +1 604 464 8144  
Telefax: +1 604 941 5423  
www.kongsberg-mesotech.com  
Email: km.sales.vancouver@kongsberg.com



**KONGSBERG**

## Table of contents

<b>1</b>	<b>INTRODUCTION.....</b>	<b>5</b>
<b>2</b>	<b>TYPICAL SYSTEM DIAGRAM .....</b>	<b>6</b>
<b>3</b>	<b>PROCESSOR OVERVIEW.....</b>	<b>7</b>
<b>4</b>	<b>INSTALLATION DETAILS.....</b>	<b>9</b>
4.1	Cable Adapter for the 4-Port Serial Card.....	9
<b>5</b>	<b>MS1000 SONAR SYSTEM WIRING .....</b>	<b>10</b>
5.1	Serial Card pinout .....	10
5.2	Sonar Head electrical connections .....	13
<b>6</b>	<b>MS1000 SOFTWARE INSTALLATION .....</b>	<b>14</b>
6.1	REMOVE OLD INSTALLATION .....	14
6.2	INSTALL NEW SOFTWARE .....	14
6.2.1	Installing the MS1000 software.....	14
6.2.2	Set the host sonar applications with Admin rights .....	15
6.2.3	Configure Dual Serial Ports if necessary.....	16
6.2.4	Set the sonar application to Autostart.....	18
6.2.5	Disable User Account Control (UAC) .....	18
6.2.6	Verify Autostart operation.....	19
6.2.7	Enable serial ports .....	19

This page intentionally left blank

# 1 INTRODUCTION

This document provides product information related to the configuration and operation of the supplied PC as a MS1000 Sonar Processor.

The MS1000 Sonar Processor is a 2U rack-mount PC system running the MS1000 Software w/ security key as well as incorporating an additional high performance serial card.

The processor provides a MOXA multi-protocol telemetry interface cards for operating the digital sonar heads and altimeters available from Kongsberg Mesotech Ltd.

The MS1000 Sonar Processor's rugged design and reliable performance is ideally suited for marine applications of the MS1000 systems. In addition to the sonar telemetry link, external sensors such as GPS can be attached to the MS1000 processor using standard serial interfaces. The system provides real-time sonar data and sensor recording so as to allow off-line post processing and playback.

For detailed hardware information and user manuals please consult the documentation provided by the OEM manufacturers on the CD/DVDs supplied with the PC. Typically the following information is included:

1. HATTELAND DISPLAY – Product Material CD or USB
2. Moxa – Serial Board Software CD or USB

*NOTE: The product configuration and peripheral type and manufacturer are subject to change without notice. In the event of a discrepancy between this document and configuration of the supplied PC, the OEM documentation supplied with the PC takes precedence.*



## 2 TYPICAL SYSTEM DIAGRAM

The figure below shows a typical ROV installation diagram with the MS1000 processor controlling multiple sonar heads from the topside using a RS485 serial interface. The power and telemetry are supplied to the sonars by the ROV MUX and power distribution system.

This configuration is typically intended for MS1000 systems using multiple heads (only four serial channels & heads are shown).

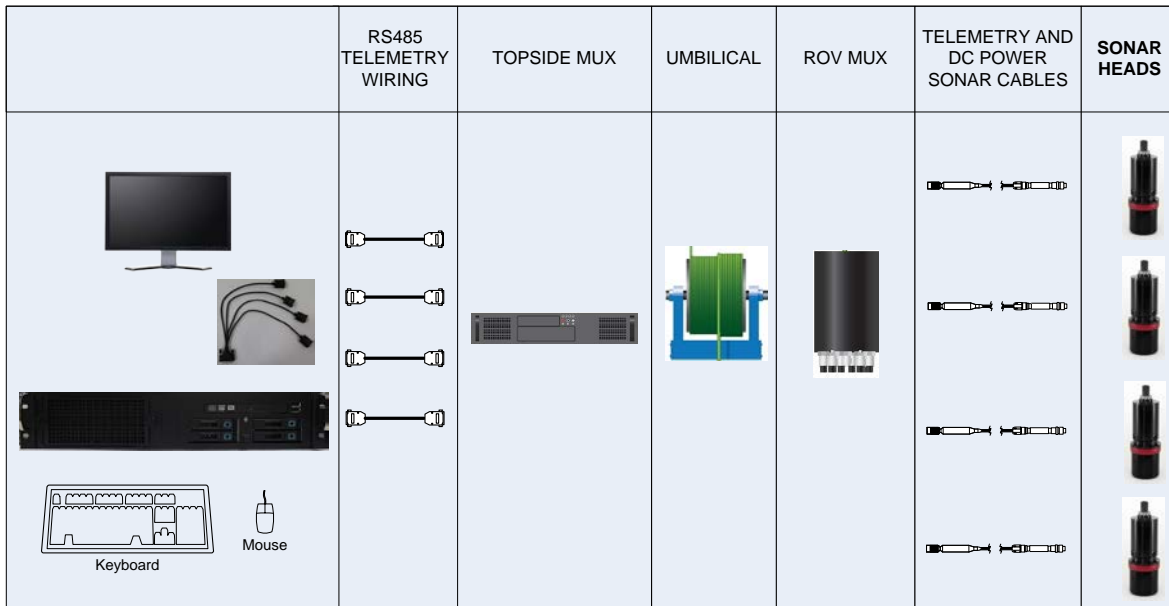

### 3 PROCESSOR OVERVIEW

The following pictures highlight the key components accessible from the front and rear sides of the Sonar Processor PC.

#### Sonar Processor – Front View

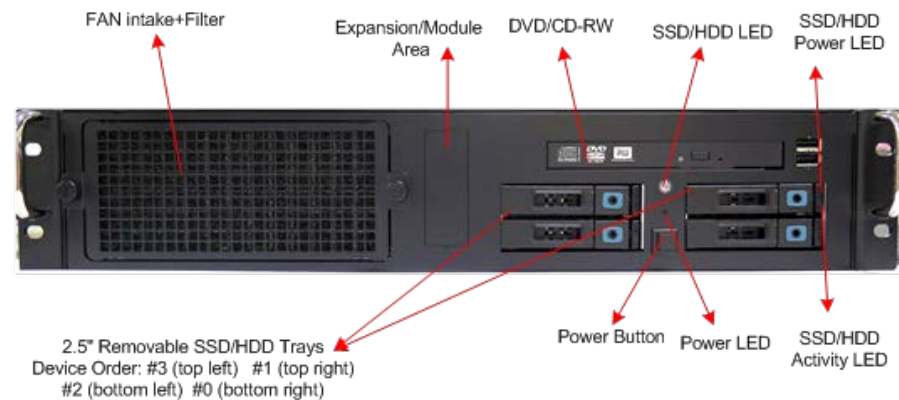

The processor's front panel allows access to the Power switch, hard drive bays, USB ports and the CD/DVD drive. The dust filter is accessible by removing the Fan Intake screen.

## Sonar Processor – Rear View

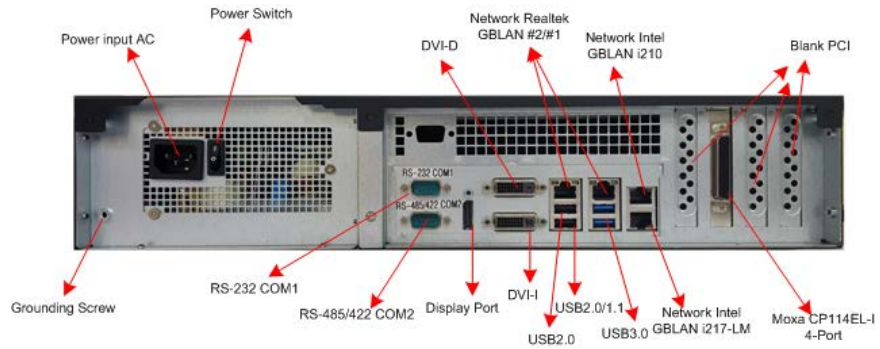

The rear panel provides connectivity for AC power, standard peripherals and the enhanced performance peripherals that are included in the PC configuration to satisfy the connectivity and display requirements of the Sonar Processor.

## 4 INSTALLATION DETAILS

The PC installation instructions including the rack mounting options are provided by the OEM PC manufacturer and are supplied with the PC.

The following paragraphs provide installation and configuration details for the enhanced PC peripherals and the associated adapter cables supplied as part of the MS1000 Sonar Processor as well as instructions on securing the AC power cord from accidental disconnect.

### 4.1 Cable Adapter for the 4-Port Serial Card

Plug in the DB44 to DB9M serial cable adapters into the MOXA Serial Adapter board, then use the DB9 connectors to interface with the RS485 telemetry cable connecting to the Topside MUX.



## 5 MS1000 SONAR SYSTEM WIRING

This section outlines the typical MS1000 system telemetry wiring for ROV installations. The naming conventions for the telemetry signals use the serial card signal names for the processor side of the telemetry link and the sonar head signal names for the topside MUX to sonar head telemetry link.

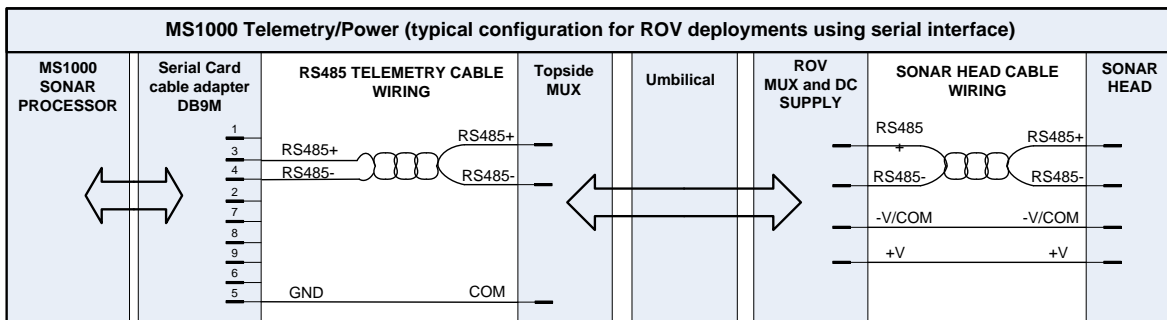

NOTE: Signal naming is the same for all KML supplied Sonar Heads. Consult the Technical Information document supplied with your sonar for pinout as the pin assignments vary as a function of the connector used.

### 5.1 Serial Card pinout

The MOXA CP-114EL-I Serial Adapter card provides one DB44 pin connector for the serial telemetry. The table describing the 44 pin connector pin out is extracted from the OEM manufacturer's documentation and provides information for all telemetry configuration options provided.

## CP-114EL/CP-114EL-I

### Board Side Pin Assignments—Female DB44

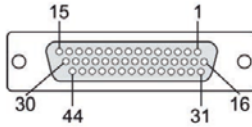

### RS-232

Pin	Signal	Pin	Signal	Pin	Signal	Pin	Signal
1	TxD3	13	TxD0	25	DTR1	37	GND
2	RxD3	14	RxD0	26	DSR1	38	-
3	RTS3	15	RTS0	27	-	39	DCD1
4	-	16	CTS3	28	CTS0	40	-
5	TxD2	17	DTR3	29	DTR0	41	GND
6	RxD2	18	DSR3	30	DSR0	42	DCD0
7	RTS2	19	-	31	DCD3	43	-
8	-	20	CTS2	32	-	44	GND
9	TxD1	21	DTR2	33	GND		
10	RxD1	22	DSR2	34	-		
11	RTS1	23	-	35	DCD2		
12	-	24	CTS1	36	-		

### RS-422 & 4-wire RS-485

Pin	Signal	Pin	Signal	Pin	Signal	Pin	Signal
1	RxD3(+)	13	RxD0(+)	25	RxD1(-)	37	GND
2	TxD3(+)	14	TxD0(+)	26	-	38	-
3	-	15	-	27	-	39	TxD1(-)
4	-	16	-	28	-	40	-
5	RxD2(+)	17	RxD3(-)	29	RxD0(-)	41	GND
6	TxD2(+)	18	-	30	-	42	TxD0(-)
7	-	19	-	31	TxD3(-)	43	-
8	-	20	-	32	-	44	GND
9	RxD1(+)	21	RxD2(-)	33	GND		
10	TxD1(+)	22	-	34	-		
11	-	23	-	35	TxD2(-)		
12	-	24	-	36	-		

The Sonar Processor's factory configuration is for 2-Wire **RS485** interface and the signal naming and pinout corresponding for this telemetry mode is as follows:

### 2-wire RS-485

Pin	Signal	Pin	Signal	Pin	Signal
1	Data3+(B)	16	-	31	-
2	-	17	Data3-(A)	32	-
3	-	18	-	33	GND3
4	-	19	-	34	-
5	Data2+(B)	20	-	35	-
6	-	21	Data2-(A)	36	-
7	-	22	-	37	GND2
8	-	23	-	38	-
9	Data1+(B)	24	-	39	-
10	-	25	Data1-(A)	40	-
11	-	26	-	41	GND1
12	-	27	-	42	-
13	Data0+(B)	28	-	43	-
14	-	29	Data0-(A)	44	GND0
15	-	30	-		

One DB44 to four DB9M adapter cable (*OEM manufacturer P/N CBL-M44M9x4-50*) is supplied with each serial card to allow using standard serial connectors for the wiring to the topside MUX. As mentioned above, the Sonar Processor factory configuration is for the 2-wire **RS485** interface and the signal naming and pinout corresponding for the telemetry is applicable for the system wiring. The pinout for the DB9M connectors is as follows:

### Device Side Pin Assignments

#### Male DB9 (CBL-M44M9x4-50)

Pin	RS-232	RS-422/RS-485-4W	RS-485-2W
1	DCD	TxD-(A)	-
2	RxD	TxD+(B)	-
3	TxD	RxD+(B)	Data+(B)
4	DTR	RxD-(A)	Data-(A)
5	GND	GND	GND
6	DSR	-	-
7	RTS	-	-
8	CTS	-	-
9	-	-	-

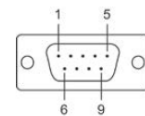

## 5.2 Sonar Head electrical connections

Name	Description
-V / COM	<p><i>Power supply / Telemetry common</i></p> <p>Also provides a ground reference for RS232C telemetry.</p>
+V	<p><i>Power supply input</i></p> <p>Connect this to a +22...28VDC power supply capable of delivering 300mA continuous (2 amp peak), such as the MS1000 Power Supply Box or ROV power supply</p>
RS485+ (232 DWN)	<p><i>Telemetry RS232C RX input / RS485 active HI balanced I/O signal</i></p> <p>For RS232 connect to the RS232 TX signal of the host computer. For RS485 connect to the RS485 active HI balanced bi-directional signal of the Sonar Processor or MS1000 Power Supply Box.</p>
RS485- (232 UP)	<p><i>Telemetry RS232C TX output / RS485 active LO balanced I/O signal</i></p> <p>For RS232 connect to the RS232 RX signal of the host computer. For RS485 connect to the RS485 active LO balanced bi-directional signal of the Sonar Processor or MS1000 Power Supply Box.</p>

NOTE: Signal naming is common for all KML supplied Sonar Heads. Consult the Technical Information document supplied with your sonar for pinout as the pin assignments vary as a function of the connector used.



## 6 MS1000 SOFTWARE INSTALLATION

The MOXA and MATROX software is installed by the PC's manufacturer. The MS1000 software is installed by Kongsberg Mesotech Ltd. This section describes the procedure for re-installing or upgrading the MS1000 Sonar Processor Software on a PC supplied by KML and running Windows® 7.

### 6.1 REMOVE OLD INSTALLATION

If a previous version of Sonar Processor Software is already installed, uninstall it before installing the new version:

1. Close all active applications.
2. Activate "Control Panel" through "My Computer" icon on the desktop or through "Start – Control Panel".
3. Double-click **Add/Remove Programs**.
4. Find and select the previous version Sonar Head Software in the list of "Currently installed programs".
5. Click **Remove**.
6. Select **Yes** for all subsequent questions.

### 6.2 INSTALL NEW SOFTWARE

#### 6.2.1 Installing the MS1000 software

1. Insert the USB Flash Drive containing the application software into one of the PC's USB ports.
2. Navigate to the USB Flash drive and go to the application software directory.
3. Double click on the **nnnnn\_Vxxxx\_Setup** application (nnnnn is the application name: MS1000; xxxx is the software version).
4. Click **Yes** to install the software.

5. The User Account Control (UAC) window will appear – select **Yes** to accept the unknown publisher.
6. Select **English** as the preferred language to use in the application software. Click **Next**.
7. The setup Wizard window will appear, click **Next** to continue.
8. Keep the default location for the program files (C:\KML\nnnn\_Vxxxx), click **Next**.
9. Keep the default Full Installation setting, click **Next**.
10. Keep the default shortcut in start menu folder setting, click **Next**.
11. Click **Install** to run the installation program.
12. Select **Yes** to install the KML USB converter.
13. The KML USB Setup Wizard window will appear, click **Next**.
14. Keep the default location for the files (C:\KML\NewUSBdriver), click **Next**.
15. Click **Install** to run the installation program.
16. Click **Finish** to close the KML USB Setup Wizard. The Sentinel (dongle) drivers will now be installed.
17. Click **Finish** to close the parser setup.
18. Click **Finish** to close the KML application software Setup Wizard.
19. Close the CD/DVD navigation window.

### 6.2.2 Set the host sonar applications with Admin rights

This is recommended in order to allow the application to access PC resources without the need for user intervention.

This procedure is performed for each installed sonar applications (MS1000 has two: one for full operations (MS1000) and one for simplified operations (MS1000 Express)).

1. **Right click** on the desktop icon for the application.
2. Select **Properties** from the drop-down menu.
3. Select **Advanced**.
4. Select **Run as administrator**, click **OK**.
5. Click **Apply**.
6. Click **Continue**.
7. Click **OK**.

### 6.2.3 Configure Dual Serial Ports if necessary

For each of the Moxa CP-114EL” four serial port cards installed, it is necessary to configure each of the ports in Windows. The assumption will be the driver is already installed.

1. After the driver is installed, go to Device Manager and find the "MOXA CP-114EL Series (PCI Express Bus) in the device list.

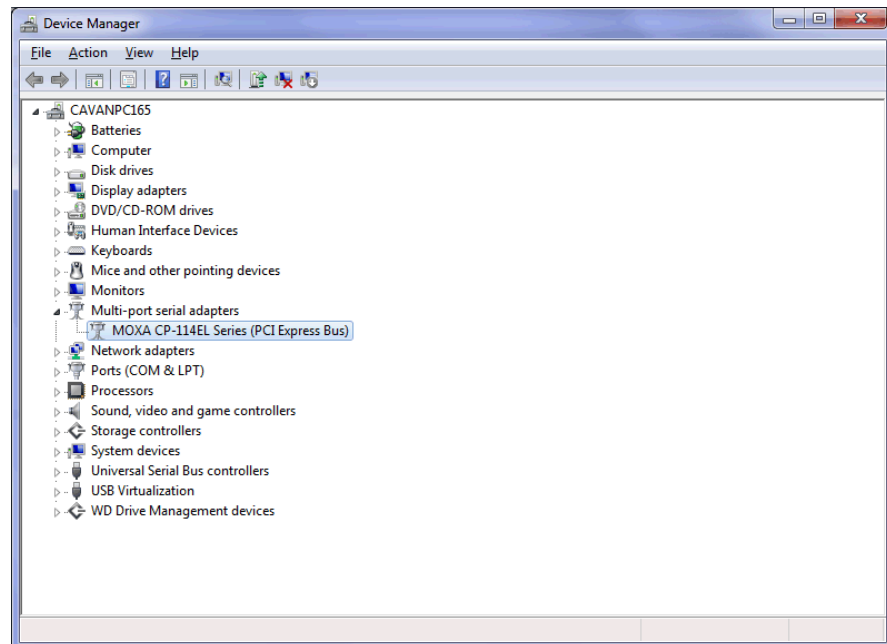

2. Right-click the MOXA CP-114EL Series (PCI Express Bus), select "Properties", select the "Port Configuration" tab, and click "Port Setting" button.

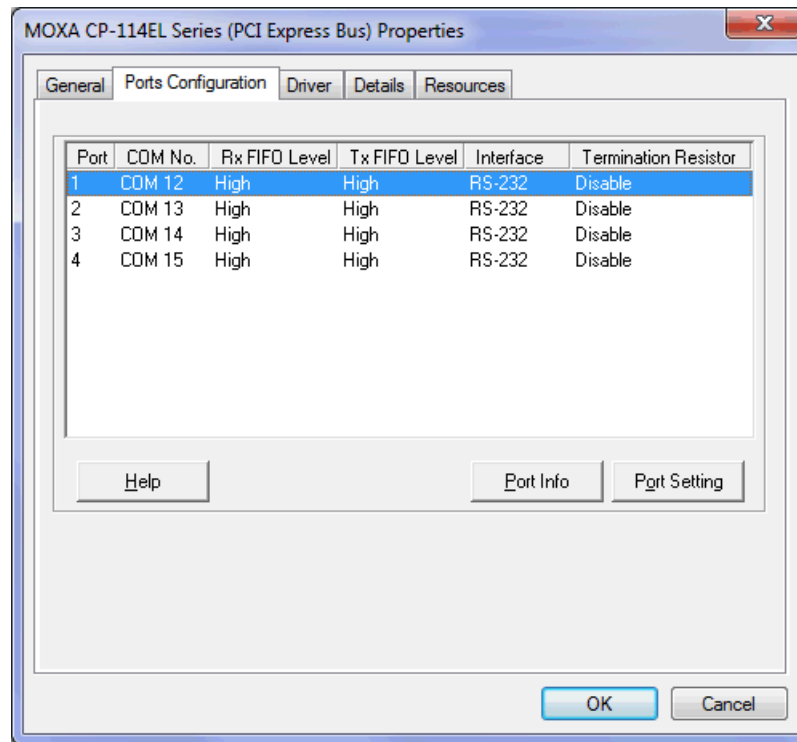

1. From the Port Settings, change the "Interface" from RS-232 to RS-485 2W, and make sure the "Set the change to all ports" is checked..

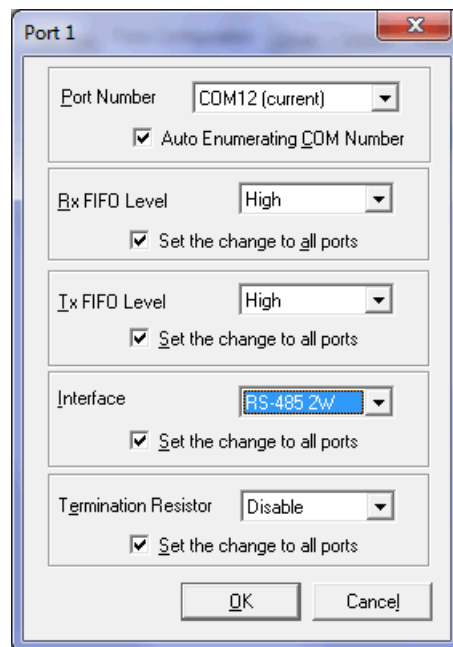

2. **Close** the Device Manager window.

## 6.2.4 Set the sonar application to Autostart

This process is required in order to have the sonar application automatically start up when the user switches on the PC.

1. Click the Windows **Start** Button (bottom left of Windows screen).
2. In the command line prompt type **shell:startup** then press **Enter**. This will open the Startup folder.
3. On the desktop **right click** on the application software icon (note: for MS1000 use only the non Hub application) and select **Copy**.
4. In the Startup folder **right click** and select **Paste**.
5. Close the Startup folder

## 6.2.5 Disable User Account Control (UAC)

It is recommended that UAC be disabled in order to avoid the user having to confirm that they do wish to run the application every time it is started.

1. Click the Windows **Start** Button (bottom left of Windows screen).
2. Select the **Control panel**.
3. Select **User Accounts**.
4. Select **Change User Account Control Settings**.
5. Move the slider bar down to **Never notify**.
6. Click **OK**.
7. In the confirmation window click **Yes**.
8. Close the Control panel window.

## 6.2.6 Verify Autostart operation

1. **Restart** the PC
2. Verify that the sonar application software auto starts.
3. Verify the MS1000 Application is checked to allow the program to communicate through Windows Firewall under **Home/Work (Private) Networks** in the Windows Firewall window.
4. Click on the sonar application logo (top right of screen).
5. Verify that the security key serial number is displayed.

## 6.2.7 Enable serial ports

It is recommended that the following procedure be followed in order to enable all PC COM ports that may be used for connecting to sonar heads.

1. From the sonar application menu go to **Setup/Connect Sonar**.
2. Select each of the displayed **COM ports** in turn and select **Enable for head control**.
3. Click **Apply**.
4. Click **OK**.
5. **Exit** the sonar application.
6. Click **Save** on the Settings Window.

- END OF DOCUMENT -